

**ATTACHMENT 2
PROPOSAL SUMMARY**

**Location: Colchester RecPlex
215 Old Hebron Rd.,
Colchester CT 06415**

Total Cost: \$238,979

Fournier Irrigation, LLC
33 Sterling Road
East Hartford, CT 06108

Include detailed breakdown of cost including, but not limited to:

- Design \$2,000
- Equipment (inclusive of all structures, components, signage, hardware, equipment manuals and operations manuals) \$105,000
- Installation \$109,979
- Any other equipment-related improvements necessary to complete the project. \$22,000

1. An introduction containing the following information:
 - a. A complete description of capability and history of the contractor.
 For complete history go to our web page at www.fournierirrigation.com
 - b. History of similar projects completed within the last three years, including cost and client contact information.

Amazon Warehouse, Windsor	\$92,812	Bob St. Jaques	860-250-3682
Garden Homes, Bloomfield	\$166,610	Rob Goldstein	973-725-8619
Fast Pitch Nation, Windsor	\$113,442	Dave Rocha	860-883-3729
Johnson Middle School, Colchester	\$49,730		
ESPN Campus, Bristol	\$174,458	Matt Bagshaw	860-982-3295
Deer Valley Apts, Ellington	\$150,000	Erik Santini	860-416-1193
 - c. A brief description of the proposed schedule including how the project would be organized.
 Schedule is based on the needs of the Town
 - d. A list of sub-contractors to be used on the project
 Hayword Construction

2. A list of not less than three (3) references including product or service provided, name of agency, contact person, phone number and/or e-mail.

SiteOne Irrigation Supply	Randy Baker	860-528-9182
Town of Ellington	Tim Webb	860-870-3140
Scott Prestilio – Insurance Agent		203-605-5492

3. Identify any state contract numbers or certifications. Such pricing is to be incorporated in the cost proposal(s).

Mike Fournier – CT Certified Backflow Preventer Tester	204069
Mike Fournier – CT licensed plumber	J# 208659

4. Proposal Summary Form (Attachment 2)

5. Irrigation design proposal. For each design proposal, provide the following:
 - a. A scaled site plan showing the proposed equipment and installation.
 - b. Drawings and manufacturer’s printed literature and specifications for each item or component being proposed.
 - c. A detailed breakdown of cost including, but not limited to:
 - i. Design
 - ii. Equipment (inclusive of all structures, components, signage, hardware, equipment manuals and operations manuals)
 - iii. Installation

Series 825Y

Reduced Pressure Zone Assemblies

Size: 3/4" - 2" (20mm - 50mm)

The FEBCO Series 825Y Reduced Pressure Zone Assemblies are used to protect against high hazard (toxic) fluids in water services to industrial plants, hospitals, morgues, mortuaries, and chemical plants. They are also used in irrigation systems, boiler feed, water lines and other installations requiring maximum protection.

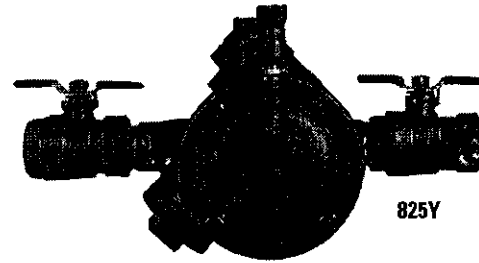

Features

- Ultimate mechanical protection of potable water, against hazards of cross-connection contamination.
- Meets all specifications of AWWA, ASSE, CSA and approved by the Foundation for Cross-connection Control and Hydraulic Research at the University of Southern California.
- Flow curve generated by the Foundation of Cross-Connection Control and Hydraulic Research at the University of Southern California.
- Modular relief valve for ease of maintenance.
- Simple Service procedures. All internal parts serviceable in line.
- Low head loss.
- Spring loaded "Y" type check valves.
- Internal relief valve pressure sensing passages.
- Replaceable seat rings on all sizes.
- End connection - NPT ANSI / ASME B1.20.1

Specifications

The reduced pressure zone assembly shall consist of two independently operating, spring loaded, "Y" pattern check valves and one hydraulically dependent differential relief valve. The assembly shall automatically reduce the pressure in the "zone" between the check valves to at least 5psi lower than inlet pressure. Should the differential between the upstream and the zone of the unit drop to 2psi, the differential relief valve shall open and maintain the proper differential.

Mainline valve body and caps including relief valve body and cover shall be bronze. Check valve moving member shall be center stem guided. All hydraulic sensing passages shall be internally located within the mainline and relief valve bodies and relief valve cover. Diaphragm to seat area ratio shall be 10:1 minimum. Relief valve shall have a removable seat ring. Check valve and relief valve components shall be constructed so they may be serviced without removing the valve body from the line. All seat discs shall be reversible. Shutoff valves and test cocks shall be full ported ball valves.

The assembly shall be rated to 175psi (12.1 bar) working pressure and water temperature range from 32°F to 140°F (0°C - 60°C).

The assembly shall meet the requirements of ASSE Standard 1013; AWWA Standard Code C511; CSA Standard B64.4; and approved by the Foundation for Cross-Connection Control and Hydraulic Research at the University of Southern California.

Operation

In a flow condition the check valves are open with the pressure between the checks, called the zone, being maintained at least 5.0psi lower than the inlet pressure and the relief valve is maintained closed.

Should abnormal conditions arise under no flow or reversal of flow, the differential relief valve will open and discharge to maintain the zone at least 2psi lower than the supply.

When normal flow resumes, the zone's differential pressure will resume and the relief valve will close.

Typical Installation

Reduced pressure zone assemblies should be installed with minimum clearance of 12' (300mm) between relief valve discharge port and floor or grade. They must be installed where discharge will not be objectionable and can be positively drained away. They should be installed where easily accessible for testing and maintenance and must be protected from freezing. Thermal water expansion and/or water hammer downstream of the backflow preventer can cause excessive pressure. Excessive pressure situations should be eliminated to avoid possible damage to the system and assembly.

Refer to local codes for specific installation requirements. Some codes may prohibit vertical installation.

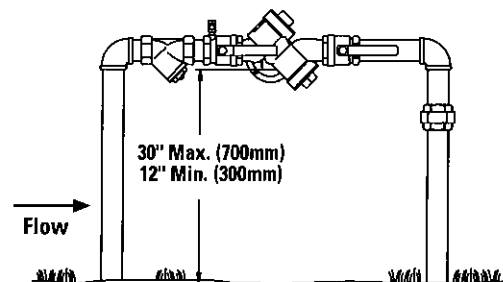

Job Name _____
 Job Location _____
 Engineer _____
 Approval _____

Contractor _____
 Approval _____
 Contractor's P.O. No. _____
 Representative _____

FEBCO product specifications in U.S. customary units and metric are approximate and are provided for reference only. For precise measurements, please contact FEBCO. FEBCO reserves the right to change or modify product design, construction, specifications, or materials without prior notice and without incurring any obligation to make such changes and modifications on FEBCO products previously or subsequently sold.

**SUBMITTED FOR
APPROVAL BY**

FOURNIER IRRIGATION, LLC

CRESLINE®
CRESLINE PLASTIC PIPE CO., INC.

**PVC PRESSURE PIPE
SDR-26 & SDR-21**

FORM NO. 761LW SPECIFICATIONS
PRICES ARE LISTED ON FORM MLP-2.
PVC CEMENT ON FORM 466.
PLEASE ORDER BY PART NUMBER.

DECEMBER, 2010

PPFA MEMBER
PLASTIC PIPE
AND FITTINGS
ASSOCIATION

SDR-26 PRESSURE PIPE 160 PSI PVC1120 ASTM D-2241 	SIZE	O.D.	MIN. WALL	WEIGHT PER 100'	SOCKET DEPTH INCHES	FEET PER PALLET	PALLETS PER T.L.	BELLED PART NO.
	1½"	1.660	.064	20.93	2.750	4000	32	45243
1½"	1.900	.073	27.31	3.000	3600	28	45280	
2"	2.375	.091	42.51	3.000	2800	24	45345	
2½"	2.875	.110	62.13	3.500	2240	20	45410	
3"	3.500	.135	92.81	4.000	1500	20	45470	
4"	4.500	.173	156.97	6.000	580	28	47075	
6"	6.625	.255	342.71	6.500	400	20	47120	
8"	8.625	.332	581.78	7.000	280	16	47735	

NOTE: 8" SDR-26 IS DUAL MARKED FOR SCH-40 PIPE.

SDR-21 PRESSURE PIPE 200 PSI PVC1120 ASTM D-2241 	SIZE	O.D.	MIN. WALL	WEIGHT PER 100'	SOCKET DEPTH INCHES	FEET PER PALLET	PALLETS PER T.L.	BELLED PART NO.
	¾"	.840	.062	9.81	2.000	8400	44	46105
¾"	1.050	.060	12.11	2.125	6600	40	46157	
1"	1.315	.063	16.17	2.375	5400	32	46207	
1¼"	1.660	.079	25.59	2.750	4000	32	46243	
1½"	1.900	.090	33.32	3.000	3600	28	46285	
2"	2.375	.113	52.32	3.000	2800	24	46345	
2½"	2.875	.137	76.53	3.500	2240	20	46410	
3"	3.500	.167	113.71	4.000	1500	20	46470	
4"	4.500	.214	192.22	5.000	580	28	47275	
6"	6.625	.316	420.11	6.500	400	20	47320	
8"	8.625	.410	710.96	7.000	280	16	47335	

*SDR 13.5 - 315 PSI

NOT RECOMMENDED FOR THREADING.

STANDARD LENGTH 20 FT. EXCEPT 4, 6 AND 8 IN. DIA. WHICH ARE 20 FT. LAYING LENGTH.

CRESLINE PLASTIC PIPE CO., INC.

www.cresline.com

600 Cross Pointe Blvd.
264 Silver Spring Rd.
2100 South 36th St.
3801 East Hwy. 31

Evansville, IN 47715
Mechanicsburg, PA 17050
Council Bluffs, IA 51501
Corsicana, TX 75109

812-428-9350
717-766-2666
712-322-2294
903-872-8475

Fax 812-428-9353
Fax 717-897-2371
Fax 712-322-8673
Fax 903-872-7732

Warranty Information

STATEMENT OF WARRANTY

Hunter Industries Incorporated ("Hunter") warrants the following products to be free of defects in materials or workmanship under normal use for a period of two (2) years from the original date of manufacture: PGP-ADJ®, PGJ, MP Rotator family, PS family SRS, Pro-Spray®, Spray Nozzles, PCN, PCB, AFB, HPV, PGV family, Pro-ASV, SRV, SRC, XC family, Pro-C family, SRR, ROAM, SVC, WVP, WVS, MP Rotator, PLD, PACZ, PCZ, AVB, PSR, HCV, SJ, HFT family, SBE family, RZWS, ET System, ROAM and Solar-Sync). Hunter warrants the following products to be free of defects in materials or workmanship under normal use for a period of three (3) years from the original date of manufacture: PGP Ultra family. Hunter warrants the following products to be free of defects in materials or workmanship under normal use for a period of one (1) year from the original date of manufacture: SRM family, Micro Sprays and Stream Drippers. Hunter warrants the following products to be free of defects in materials or workmanship under normal use for a period of five (5) years from the original date of manufacture: Institutional Spray, G-Spray, MPR-40 family, I-20, I-25, I-35, I-40, I-60 and I-90 families, ICC and ACC controller families, ICD Decoder Products, ICR Remotes, IMMS™ Central Control Products, "Clik" Sensors, HQ, ICV plastic, and IBV brass valves, ICZ and PLD tubing. If a defect in a Hunter product is discovered during the applicable warranty period, Hunter will repair or replace, at its option, the product or the defective part. This warranty does not extend to repairs, adjustments, or replacement of a Hunter product or part that results from misuse, negligence, alteration, modification, tampering, or improper installation and/or maintenance of the product. This warranty extends only to the original installer of the Hunter product. If a defect arises in a Hunter product or part during the warranty period, you should contact your local Hunter Authorized Distributor.

HUNTER'S OBLIGATION TO REPAIR OR REPLACE ITS PRODUCTS AS SET FORTH ABOVE IS THE SOLE AND EXCLUSIVE WARRANTY SET FORTH BY HUNTER. THERE ARE NO OTHER WARRANTIES, EXPRESSED OR IMPLIED, INCLUDING WARRANTIES OF MERCHANTABILITY AND FITNESS FOR A PARTICULAR PURPOSE. HUNTER WILL NOT BE LIABLE TO ANY PARTY IN STRICT LIABILITY, TORT, CONTRACT, OR ANY OTHER MANNER FOR DAMAGES CAUSED OR CLAIMED TO BE CAUSED AS A RESULT OF ANY DESIGN OR DEFECT IN HUNTER'S PRODUCTS, OR FOR ANY SPECIAL, INCIDENTAL OR CONSEQUENTIAL DAMAGES OF ANY NATURE.

If you have any questions concerning the warranty or its application, please write to: Marketing Department, Hunter Industries Incorporated, 1940 Diamond Street, San Marcos, CA 92078, U.S.A.

ASAE CERTIFICATION STATEMENT

Hunter Industries Incorporated certifies that pressure, flow rate, and radius data for these products were determined and listed in accordance with ASAE Standard S398.1, Procedure for Sprinkler Testing and Performance Reporting, and are representative of performance of production sprinklers at the time of publication. Actual product performance may differ from the published specifications due to normal manufacturing variations and sample selection. All other specifications are solely the recommendation of Hunter Industries Incorporated.

www.hunterindustries.com

Hunter®

EZDS DECODER SYSTEM

Platform: **HCC or ICC2**
Type: **Modular Decoder**

FEATURES

- Cost-effective two-wire system for HCC and ICC2 controllers
- Up to 54-station capacity, plus master valve
- No special wire or connectors required
- Allows hybrid operations of conventional and decoder stations (54 total stations max per controller)
- Programmable decoders with no serial numbers
- Wire paths possible for over 3,000'; see wiring table
- No special grounding or surge arrestors required in-line.
- EZ-1 single-station decoders have status LED for positive diagnostics
- P/MV can be activated by decoder or direct controller output
- EZ-DM output module works in any controller module slot

ELECTRICAL SPECIFICATIONS

- Electrical output on two-wire path: 24VAC~, 50/60 Hz
- Up to two standard 24VAC solenoids per EZ-1 decoder output
- Simultaneous stations on: Two, plus master valve
- Wire paths to field: Two (each may be tee-spliced in different directions)
- Earth grounding: Ground controller as usual (none required in-line)
- System is compatible with DUAL-S surge arrestors if desired
- EZ-1 Decoders are IP68, submersible

COMPATIBLE CONTROLLERS

- HCC (including Hydrowise™ internet control)
- ICC2 (including Centralus™ internet control)

APPROVALS

- UL, c-UL, CE, RCM, FCC, Industry Canada

WIRING TABLE

American Wire Gauge	Distance (Feet)
18 AWG	908
16 AWG	1,446
14 AWG	2,292
12 AWG	3,650

Note

Distances in the Wiring Table are calculated based on 60 Hz for American Wire Gauge, with wire temperature of 122°F and a 10% safety factor.

DECODER MODELS

Model	Description
EZ-DM	Decoder output module for HCC and ICC2 controllers
EZ-1	Single-station decoder with status LED



Decoder Output Module
Height: 4.5"
Width: 2.5"
Depth: 1.625"



Single-Station Decoder
Height: 2.875"
Width: 1.625"
Depth: 0.625"

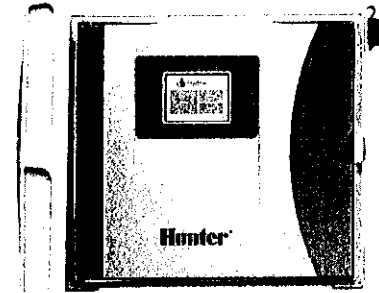

Compatible with HCC Controller

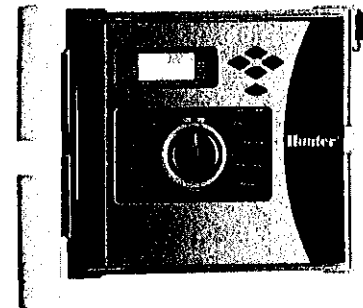

Compatible with ICC2 Controller

CONTROLLERS

1½" AND 2" PGV



These reliable valves provide long-lasting performance for larger systems.

KEY BENEFITS

- External/internal manual bleed allows for quick and easy activation at the valve
- Double-beaded diaphragm seal design ensures leak-free performance
- Captive bonnet screws eliminate the possibility of lost parts during disassembly
- Triple-tool bonnet screws are compatible with standard or Phillips screwdrivers as well as a nut driver
- Each valve available with globe or angle configuration for convenient placement
- Encapsulated solenoid with captive plunger used on every Hunter valve provides hassle-free service
- Flow control maximizes efficiency and prolongs the life of the system

USER-INSTALLED OPTIONS

- Accu Sync® Pressure Regulator at the valve*
- DC-Latching Solenoid for battery-operated controllers (P/N 458200)
- Solenoid conduit cover (P/N 464322)
- Reclaimed flow control handle (P/N 607105)

FACTORY-INSTALLED OPTIONS

- LS: Valve without solenoid
- DC: DC-Latching Solenoid for battery-operated controllers

OPERATING SPECIFICATIONS

- Flow:
 - PGV-151: 20 to 120 GPM
 - PGV-201: 20 to 150 GPM
- Recommended pressure range: 20 to 150 PSI
- Temperature rating: 150°F
- Warranty period: 2 years

SOLENOID SPECIFICATIONS

- 24 VAC solenoid
 - 350 mA inrush, 190 mA holding, 60 Hz
 - 370 mA inrush, 210 mA holding, 50 Hz
- Accu Sync product information

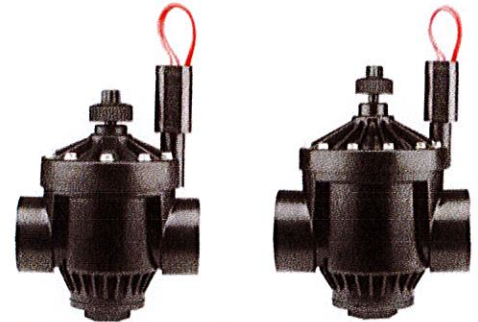

PGV-151
Inlet diameter: 1½"
Height: 7½"
Length: 5¾"
Width: 4½"

PGV-201
Inlet diameter: 2"
Height: 8"
Length: 6¾"
Width: 5¼"

VALVES

PGV Installed

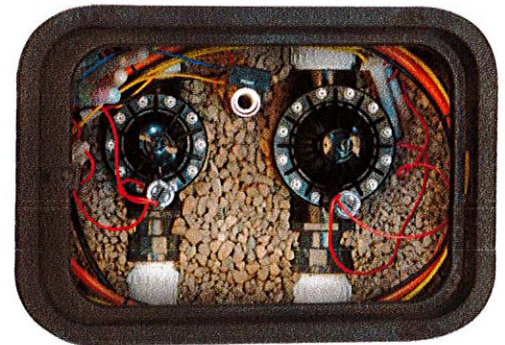

PGV-ASV – SPECIFICATION BUILDER: ORDER 1 + 2 + 3 + 4

1	Model	2	Standard Features	3	Feature Options	4	User-Installed Options
	PGV-151= 1½" PGV-201= 2"		Globe/angle valve with flow control		(blank) = No option DC = DC-Latching Solenoid battery-operated controllers LS = Less solenoid		AS-ADJ = Adjustable Accu Sync Pressure Regulator 458200 = DC-Latching Solenoid for battery-operated controllers 607105 = Reclaimed flow control handle LIT-700 = Reclaimed ID tag

Example:
PGV-201-AS-ADJ = 2" PGV globe/angle valve with flow control, user-installed adjustable Accu Sync Pressure Regulator

PGV PRESSURE LOSS IN PSI

Flow GPM	1½" Globe	1½" Angle	2" Globe	2" Angle
20	3	3	1	1
30	3	3	1	2
35	3	3	2	2
40	3	3	2	2
50	4	3.5	1	1
60	5	4	2	2
80	5.5	4.5	3	2
100	9	8	5	3
120	11.5	10.5	6	5
135			8	7
150			10	9

I-20

APPLICATION
Residential/Commercial

RADIUS
17' to 46'

FLOW RATE
0.36 to 14.8 GPM

THE I-20 IS THE ROTOR THAT'S GOT ALL THE FEATURES YOU NEED.

FEATURES

- Models: Shrub, 4", 6", 12"
- Models (stainless riser): 4", 6"
- Arc setting: 50 to 360 degrees
- Nozzle choices: 22
- Nozzle racks: 1.5 to 8.0 blue, 2.0 LA to 4.5 LA gray, 0.50 to 3.0 black, 6.0 to 13.0 green
- Factory installed rubber cover
- Through-the-top arc adjustment
- Quick check arc mechanism
- Water lubricated gear-drive
- Warranty period: 5 years

ADVANCED FEATURES

- Automatic arc return
- Non-strippable drive
- Part- and full-circle in one model
- Headed and slotted set screw
- FloStop® control
- Reclaimed water ID (optional)
- Stainless steel riser (optional)
- Drain check valve (up to 10' of elevation)
- Low angle nozzle choices

OPERATING SPECIFICATIONS

Radius: 17' to 46'
Flow Rate: 0.36 to 14.8 GPM
Recommended pressure range: 30 to 70 PSI
Operating pressure range: 20 to 100 PSI
Precipitation rates: 0.4 in/hr approx.
Nozzle trajectory: Std = 25 degrees, Low angle = 13 degrees

FACTORY INSTALLED OPTIONS

Nozzles: 1.5 to 4.0
Reclaimed water ID cover



SPECIFICATIONBUILDER

www.hunterindustries.com/I20

MODELS	STANDARD FEATURES	FEATURE OPTIONS	NOZZLE OPTIONS
I-20-00 = Shrub	Adjustable arc, plastic riser, check valve, 8 standard nozzles, and 4 low-angle nozzles	R	1.5 to 4.0 = Factory installed nozzle number
I-20-04 = 4" pop-up		NCV, R	
I-20-06 = 6" pop-up		R	
I-20-12 = 12" pop-up		R	

NCV = Without check valve
R = Reclaimed water ID

MODELS	STANDARD FEATURES	FEATURE OPTIONS	NOZZLE OPTIONS
I-20-04-SS = 4" pop-up	Adjustable arc, stainless steel riser, check valve, 8 standard nozzles, and 4 low-angle nozzles	NCV, R	1.5 to 4.0 = Factory installed nozzle number
I-20-06-SS = 6" pop-up		R	

NCV = Without check valve
R = Reclaimed water ID

EXAMPLES

I-20-04	4" pop-up, adjustable arc
I-20-12 - NCV - R - 4.0	12" pop-up, adjustable arc, without check valve, with reclaimed water ID, and 4.0 nozzle
I-20-06-SS - R - 3.0	6" pop-up, adjustable arc, stainless steel, reclaimed water ID, and 3.0 nozzle

THIS RUGGED ROTOR CAN STAND UP TO ANY COMMERCIAL JOB.

FEATURES

- Models: 4", 6"
- Arc setting: 50 to 360 degrees
- Nozzle choices: 12
- Nozzle range: #4 to #28
- Factory installed rubber cover
- Through-the-top arc adjustment
- Quick check arc mechanism
- Water lubricated gear-drive
- Warranty period: 5 years

ADVANCED FEATURES

- Automatic arc return
- Non-strippable drive
- Part- and full-circle in one model
- Color coded nozzles
- Reclaimed water ID (optional)
- Stainless steel riser (optional)
- Drain check valve (up to 10' of elevation)

OPERATING SPECIFICATIONS

Radius: 37' to 71'
 Flow rate: 3.8 to 31.5 GPM
 Recommended pressure range: 40 to 100 PSI
 Operating pressure range: 40 to 100 PSI
 Precipitation rates: 0.4 in/hr approx.
 Nozzle trajectory: 25 degrees

FACTORY INSTALLED OPTIONS

Nozzles: #4 to #28
 Reclaimed water ID cover
 High speed rotation model (stainless steel only)

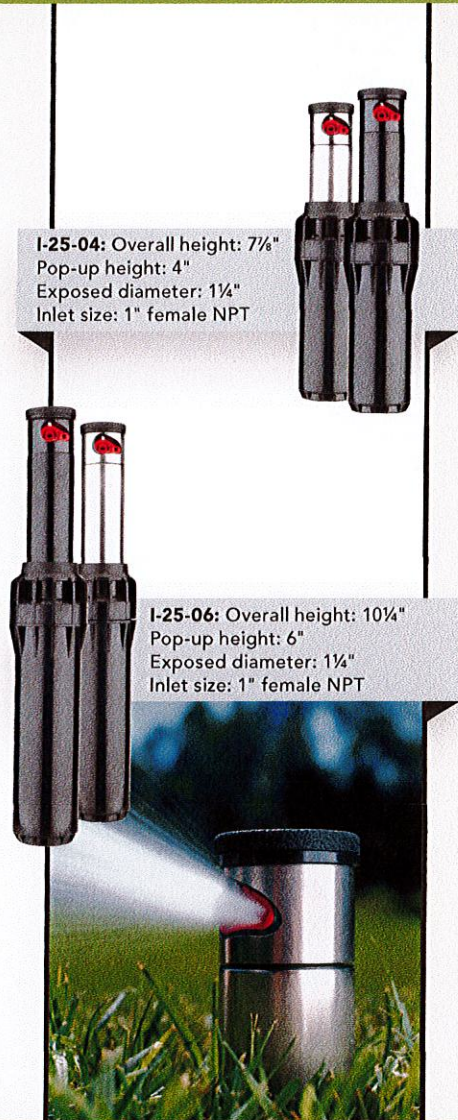

I-25-04: Overall height: 7½"
 Pop-up height: 4"
 Exposed diameter: 1¼"
 Inlet size: 1" female NPT

I-25-06: Overall height: 10¼"
 Pop-up height: 6"
 Exposed diameter: 1¼"
 Inlet size: 1" female NPT

SPECIFICATIONBUILDER www.hunterindustries.com/I25

MODELS	STANDARD FEATURES	FEATURE OPTIONS	NOZZLE OPTIONS
I-25-04 = 4" pop-up I-25-06 = 6" pop-up	Adjustable arc, plastic riser, check valve, and 5 nozzles	R, B	#4 to #28 = Factory installed nozzle number
I-25-04-SS = 4" pop-up I-25-06-SS = 6" pop-up	Adjustable arc, stainless steel riser, check valve, and 5 nozzles	R, HS, HS-R, B	#4 to #28 = Factory installed nozzle number

EXAMPLES

I-25-04	4" pop-up, adjustable arc
I-25-04-SS - R - 18	4" pop-up, adjustable arc, stainless steel riser, reclaimed water ID, and #18 nozzle
I-25-06-SS	6" pop-up, adjustable arc, stainless steel riser

Hunter®

RESIDENTIAL & COMMERCIAL IRRIGATION
Built on Innovation®

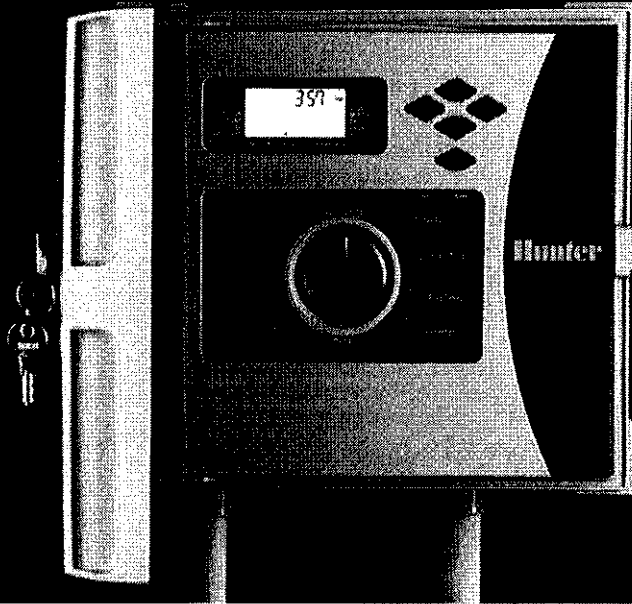

- 01 **Reliable:** Commercial controller construction that's built to last with up to 54 stations
- 02 **Powerful:** Packed full of features you expect from Hunter with 4 programs (up to 2 simultaneous), 8 start times per program, and up to 12 hours run times
- 03 **Flexible:** Easy to program and to install, using proven modular expansion with enhanced surge protection

ICC IS BACK BY POPULAR DEMAND

Hunter's classic ICC commercial controller led the industry for more than a decade with its simplicity, reliability, and power in a super competitive package. Now it's back with enhancements that will catch your eye, not hurt your wallet. ICC2 builds on its predecessor's legacy by enhancing surge protection, increasing station count, and adding a large backlit display. The new facepack and modules are even backward compatible to keep older ICC systems operational for years to come.

ICC2 can also host the EZ Decoder System (EZDS) for powerful and affordable two-wire control. Configure up to 54 stations with EZ-1 decoders or a combination of two-wire and conventional output modules.

Learn more. Visit hunterindustries.com, or contact your local sales manager.

ICC2

This reliable control system can run conventional, two-wire, or hybrid operations with the option to upgrade to Centralus™ cloud-based control.

KEY BENEFITS

- Number of stations:
 - Conventional: 8 to 38 (plastic), 8 to 54 (metal and pedestals)
 - With two-wire EZDS: up to 54 (all enclosure options)
- 4 independent irrigation programs (8 start times each) allow for customized scheduling
- 12-hour maximum station run time provides flexibility for low-flow zones
- Any 2 programs can operate simultaneously, providing more efficient watering
- 1 sensor input available for use with Solar Sync™ or any Clik sensors
- 1 P/MV output for pump start relay and master valve activation
- Backward compatibility to original ICC controllers allows for quick updates to older systems
- Upgradeable to Centralus software for web-based central control options

OPERATING SPECIFICATIONS

- Transformer input: 120/230 VAC
- Transformer output (24 VAC): 1.4 A
- Station output (24 VAC): 0.56 A
- P/MV output (24 VAC): 0.56 A
- Approvals: Wall Mounts IP44, Plastic Pedestal IP34, NEMA 3R, UL, cUL, FCC, CE, RCM
- Warranty period: 5 years

USER-INSTALLED OPTIONS

- WIFIKIT or LANKIT communications for Centralus web-based control
- Compatible with Flow-Clik™ sensor for catastrophic high-flow shutdown see page 140

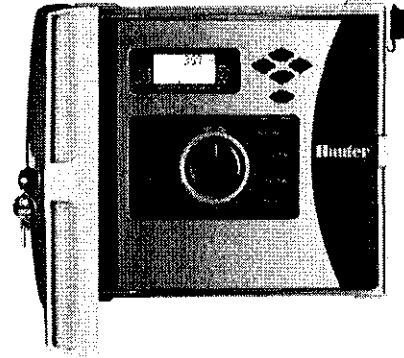

Plastic

Height: 12"
Width: 13 3/4"
Depth: 5"

Metal

(gray or stainless steel)
Height: 16"
Width: 13"
Depth: 5"

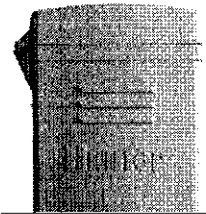
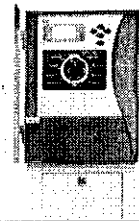

Metal Pedestal

(gray or stainless steel)
Height: 36"
Width: 11 1/2"
Depth: 5"

Plastic Pedestal

Height: 39"
Width: 24"
Depth: 17"

Model	Description
I2C-800-PL	8-station base model, plastic outdoor wall mount
I2C-800-M	8-station base model, gray metal outdoor, wall mount
I2C-800-SS	8-station base model, stainless steel, wall mount
I2C-800-PP	8-station base model, plastic pedestal
ICC-FPUP2	ICC2 retrofit kit for original ICC controllers
ICC-PED	Gray pedestal for metal wall mount
ICC-PED-SS	Stainless steel pedestal for stainless wall mount
ICC-PWB	Optional pedestal wiring board for metal pedestals

ICC2 SERIES STATION EXPANSION

Model	Description
ICM-400	4-station plug-in module with enhanced surge suppression
ICM-800	8-station plug-in module with enhanced surge suppression
ICM-2200	22-station expansion module (one per controller)
EZ-DM	54-station decoder output module (one per controller)
EZ-1	Single-station EZ decoder

Compatible with:



**Solar Sync
Sensor**
Page 136



ROAM Remote
Page 127
ROAM XL Remote
Page 128



**EZ Decoder
System**
Page 124



EPA WaterSense

Add the WaterSense-labeled Solar Sync sensor to improve the water efficiency of this controller.

SUPERIOR PATENTED WIRELESS TECHNOLOGY

Press once to temporarily deactivate rain sensor; automatically resets on next activation

Illuminates "RED" when the rain sensor is activated

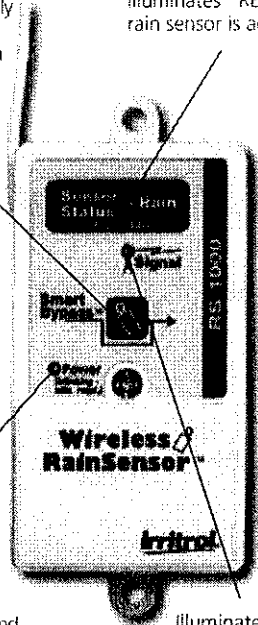

Blinking light alerts user when attention is required, e.g., need batteries replaced, no communication

Illuminates "GREEN" to ensure a good signal

SPECIFYING INFORMATION

MODEL	CONNECTION
RS Rain Sensor	500 Wired
RFS Rain/Freeze Sensor	1000 Wireless

Example: A wireless rain/freeze sensor — **RFS1000**

ADDED FEATURES

RS1000/RFS1000

- Compatible with nearly all controllers
- Visual sensor status and alert indicators verify consistent operation
- Slide/snap-on cover provides additional protection to weather-proof receiver from the elements
- Power failure memory protection
- Three-year warranty

RFS1000

- Rain and freeze sensors fully integrated into one unit
- Highly accurate 41°F digital activation point

RS500

- Compatible with virtually all controllers
- 25-foot cable (UV-resistant, white jacket included) provides installation flexibility
- Easy, tool-free conversion to normally open operation
- Five-year warranty

OPERATING SPECIFICATIONS

- Sensor type: industry-standard hygroscopic discs
- Rain sensitivity: adjustable nominal $\frac{1}{8}$ " to $\frac{3}{4}$ "
- Operating temperature: -20°F to 120°F
- Housing material: UV-resistant engineered polymer
- Wireless only features:
 - Transmission range: over 300 feet line-of-sight
 - Battery: Two CR2032 3V cells, 5-year life (typical)

ELECTRICAL SPECIFICATIONS

- Receiver power: 22-28 V ac/v dc, 100mA (to be used with Class 2, UL-approved transformer)
- Load rating: normally open or normally closed — 3A @ 24 V ac
- UL Listed, FCC, CE, IC

MODELS

Model	Description
RS1000	Wireless rain sensor
RFS1000	Wireless rain/freeze sensor
RS500	Wired rain sensor

DIMENSIONS

- **Transmitter:** H: 1 1/2", W: 1 3/4", D: 3 3/4"
- **Receiver:** H: 1 1/2", W: 1", D: 3"

OPTIONAL ACCESSORIES

- RS1000-RX rain receiver for multiple controllers
- RFS1000-RX rain/freeze receiver for multiple controllers
- RSCAP cap/disk/spindle assembly
- RSBATT-TX battery pack (includes 2 batteries)

**The COMPLETE Solution
for a Professional Pump Installation**

Easiest to select & specify – One professional package includes pump, smart controls and enclosure.

Trouble-free components – High quality materials for a clean, durable installation you will be proud of.

Hassle-free installation – Comes complete. No parts to forget, no need for shortcuts. No fuss, no errors.

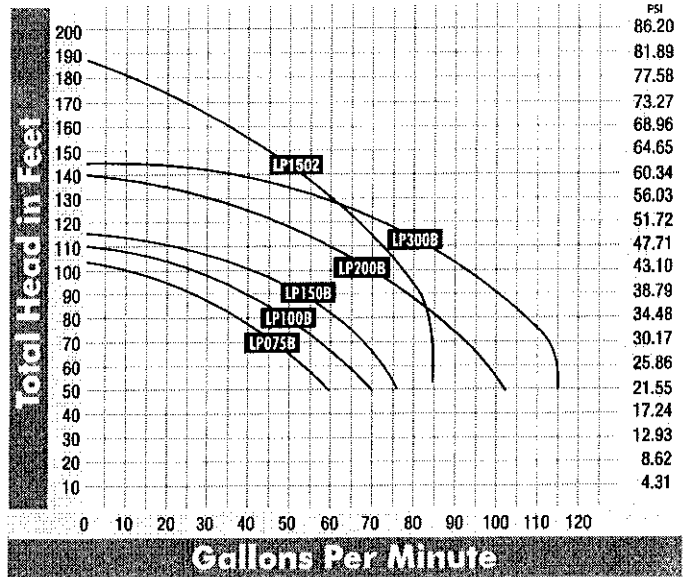

HP	Phase	Voltage	Discharge	Suction	UniversalPRO Enclosure			Control	Approx Ship Weight/Lbs	Model Number
					Height	Length	Depth			
3/4									109	CP075B
1		110/208-230							110	CP100B
1 1/2	1								120	CP150B
2		208-230							128	CP200B
3		230							143	CP300B
3/4			1 1/2"	2"	23 1/4"	31 3/4"	19 1/2"	SmartBox	115	CP075B3
1									121	CP100B3
1 1/2	3	208-230/460							117	CP150B3
2									128	CP200B3
3									137	CP300B3
2	1	230							168	CP1502B
2	3	230							163	CP1502B3

The Complete PRO II can also be ordered with a StartBox, BrainBox or custom pump control.